

BALANCES FOR CEREALS DENSITY PS/X/G











PS/X/G balances is designed for density determination of grains. They are equipped with system of automatic internal calibration, 195×195 mm weighing pan and big backlit graphic display with extender user menu.

The density determination of grains in loose form is performer with application of precision balance series PS/X 4500/G and a density measuring device of 1l volume. The density is calculated automatically by the software of balance (in accordance to tables for density measuring devices for grains). Density determination can be performed for following grains: wheat, oats, barley, rye.

Balance, as a precise measuring device is equipped with control procedures complying with ISO/GLP, memory with high capacity (reduction tables for grains), possibility of cooperation with printer or computer.

Advantages of balances series PS/X are possibility of generation of GLP procedures Balances are equipped with RS 232, PS/2 output and possibility of connection of additional display as standard.

Scales have possibility of weighing loads under the weighing pan, i.e. under-hook weighing. In such case the mass of load is measured under the pan. It is an alternative for loads with non-standard dimensions, shapes and loads which create magnetic field. Under-hook weighing is also applied for density determination of materials.

-  Counting pieces
-  Filling
-  Animal weighing
-  Density determination
-  Checkweighing
-  Percentage
-  Statistics
-  Formulation

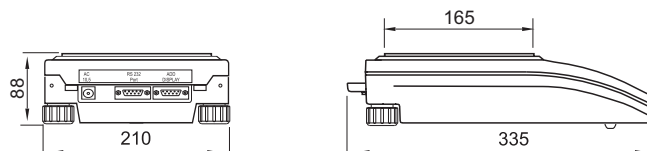

Technical data:

	PS/X 4500/G
Max capacity	4500 g
Minimal load	0,5 g
Readability	0,01 g
Tare range	-4500 g
Repeatability	0,02 g
Linearity	±0,02 g
Pan size	195×195 mm
Working temperature	+15° - +30 °C
Power supply	110 ÷ 230 V AC / 50 ÷ 60 Hz / 13,5 ÷ 16 V AC / 1,1 A
Calibration	internal (automatic)
Display	graphic (backlit)

Additional equipment:

DENSITY DETERMINATION KIT FOR GRAINS:	FOOT BUTTON FOR TARE OR PRINT FUNCTIONS
ANTI-VIBRATION TABLE (MILD STEEL OR STAINLESS STEEL)	RACK FOR UNDER HOOK WEIGHING
PRINTERS KAFKA	ADDITIONAL LCD DISPLAY
PRINTERS EPSON	EXTERNAL RECHARGEABLE BATTERY WITH CHARGER
CITIZEN LABEL PRINTER	SUITCASE FOR BALANCE
PC KEYBOARD	COMPUTER SOFTWARE: PW-WIN 2005, RAD-KEY 2000

PARTNER CORPORATION

Str. Mures nr.63,Bucuresti ,Sector 1 * Tel/fax : 021-2242257 * e-mail:office@partner.com.ro * www.partner.com.ro



This kit is designed for determination of density of cereals. Measurement of cereal density in loose state is performed with application of precise balance series WPX 4500/G and density kit for cereals. Density determination result is calculated automatically by balance software (in accordance to tables containing cereal density).

It is possible to determine the density of following cereal: wheat, oats, barley, rye.

Manufactured of brass, the density kit is additional equipment to a balance. Its volume is 1 liter.

The cereal density kit allows for determination of density according to norm: PN-73/R-74007.

CEREAL DENSITY KIT

- 1-base for measuring container
- 2-measuring container of 1 l volume
- 3-knife
- 4-ring
- 5-filling device
- 6-charging vessel

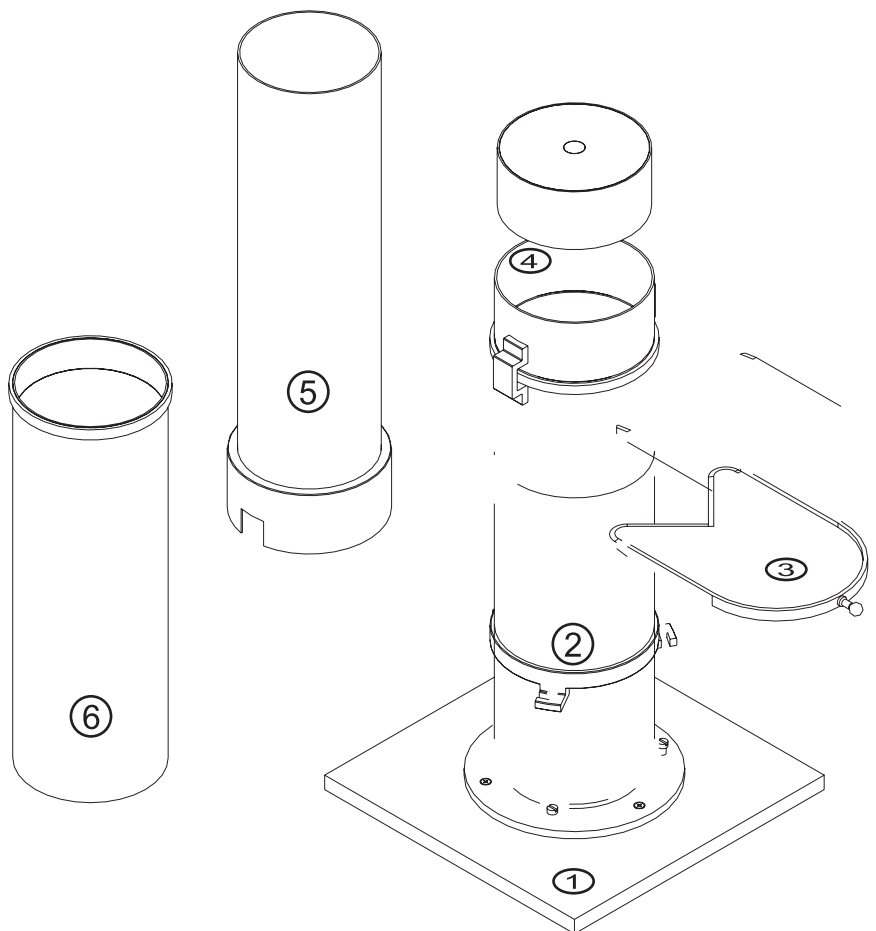

PARTNER CORPORATION

Str. Mures nr.63,Bucuresti ,Sector 1 * Tel/fax : 021-2242257 * e-mail:office@partner.com.ro * www.partner.com.ro